



Levels Ceiling 2 Bodies Ø420mm + Ø320mm

Nahtrang Design

Ceiling fixture Levels Ceiling 2 Bodies Ø420mm + Ø320mm LED 28 SW 2700-3000-4000K CASAMBI Black 1850lm

Technical features

Luminaire total power: 28W
 Real lumens: 1850 (3000K)
 Real lm/W: 66
 Correlated Colour Temperature (CCT): SW 2700-3000-4000K
 Lens / reflector angle: HORIZONTAL 101°
 Structure material: Steel
 Structure finish: Black
 Diffuser material: Glass
 Diffuser finish: Green
 Voltage / frequency: 110-277V/50-60Hz
 Dimming protocol: CASAMBI
 Power Factor: NULL
 Useful life: 50,000h L80B20
 Warranty: 5 años
 Easily recyclable luminaire



Luminotechnic features

CRI: 90
 MacAdam steps: 3
 Photobiological risk: RG1

Lampholder	Quantity	Light source power (W)
LED	1	24.4W

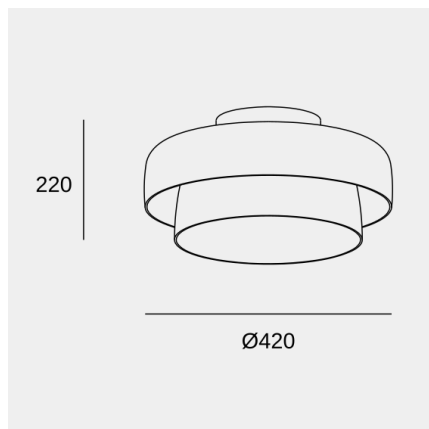

Image may not match reference. LedsC4 reserves the right to amend any of the product's components. The data related to flux, power and colour temperature may be subject to changes made by the manufacturer.



Levels Ceiling 2 Bodies Ø420mm + Ø320mm

Nahrang Design

Ceiling fixture Levels Ceiling 2 Bodies Ø420mm + Ø320mm LED 28 SW 2700-3000-4000K CASAMBI Black 1850lm

Bluetooth range

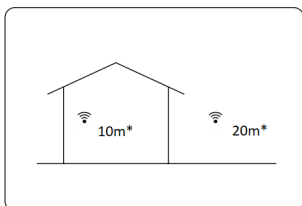

The Bluetooth range largely depends on the obstacles and architectural features of a space, such as walls and building materials

Logistics



x 1

Net weight (kg): 4.63

Packaged weight (kg): 6.76

Packaging: 1020mm x 610mm x 420mm

Image may not match reference. LedsC4 reserves the right to amend any of the product's components. The data related to flux, power and colour temperature may be subject to changes made by the manufacturer.